

[TopPage](#)>>[Search Result](#)>>7306DF

Angular Contact Ball Bearings

Bearing No. : **NACHI 7306DF**

■ Bearing Type

■ Clearance

■ Tolerance Class

Dimensions

d = 30⁰_{-0.010}
 D = 72⁰_{-0.013}
 B = 19⁰_{0.000}
 r = 1.1~2
 (Radial Direction)
 r = 1.1~3.5
 (Axial Direction)
 r1 = 0.6~1
 (Radial Direction)
 r1 = 0.6~2
 (Axial Direction)
 a = 5.2

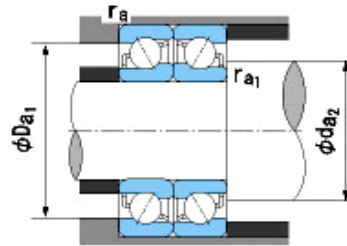
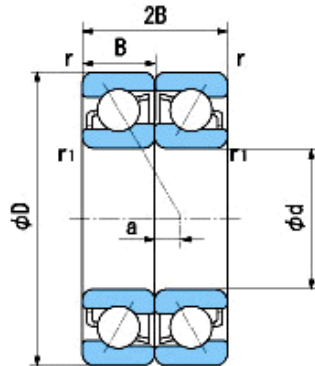

Dimensions

da1(min) = 37
 da2(min) = 35
 Da1(max) = 65
 Da2(max) = 67
 ra(max) = 1
 ra1(max) = 0.6
 Mass = 0.72 kg

Basic Dynamic Load Rating Cr :	54,500 N
Basic Static Load Rating Cor :	44,500 N
Limiting Speed ;	
Grease Lubrication :	7,000 min ⁻¹
Oil Lubrication :	9,500 min ⁻¹

	INNER RING	OUTER RING
O.D.Surface Runout with Side :		-
Axial Runout with Bore :	-	
Axial Runout with Raceway :	-	
Width Variation :	0.020	0.020
Radial Runout :	0.013	0.025